

PD140FNT60QMU-02C



Through Beam



Description

The PD140 sensor consists of an emitter, which sends out invisible, infrared light, and a receiver, capable of detecting the light from the emitter.

The sensor is encapsulated in a robust, vandal-proof aluminium/polycarbonate housing.

The lenses are adjustable in both $\pm 100^\circ$ horizontal and $\pm 15^\circ$ vertical directions, which allows flexible mounting, even when emitter and receiver are mounted at different heights.

The aspherical lens design gives a superior homogeneous light beam over the total beam angle.

- Sensor test function: the emitter has a built-in test input designed to mute the emitter and thus evaluate the sensor function. The test function is to be controlled and monitored by the door controller.

Main features

- Designed for Industrial doors and gates
- ESPE type 2, Performance level d
- For door or gate widths up to 60 m
- Modulated, infrared light
- Supply voltage: 12 to 24 VAC/DC
- 1 A, SPDT relay output
- Analogue voltage output or flashing LED indication for optical alignment help
- Built-in holder for green laser alignment accessory tool
- Yellow LED for output indication
- Green LED indication for power ON
- Connection: self-lifting terminal block, 1,5 mm² (AWG 16)
- Emitter test input
- Robust vandal-proof aluminium/polycarbonate housing
- IP65, NEMA 1. 2. 3. 3R. 3RX. 3SX. 3X. 5. 12. 12K rating
- CE, EN12453, EN12978, UL325 and UL508 approved

Main functions

- Designed for domestic and industrial doors and gates
- Detects presence or absence of persons or vehicles by interruption of the light beam from the emitter to receiver



References

Product selection key

PD140FNT60 -02C

Enter the code option instead of

Code	Option	Description	-
P	-	Photoelectric sensor	
D	-	Rectangular housing	
140	-	Length of housing	
F	-	Aluminium	
N	-	Not used	
T	-	Through-beam	
60	-	Distance [m]	
<input type="checkbox"/>	QMU	Matched sensor set (Receiver and Emitter)	
	Q	SPDT relay (Receiver)	Sensor is only available as a matched set
	MU	Mute input (Emitter)	Sensor is only available as a matched set
-02C	-	Black	

Type selection

Function	-	Code
Receiver and Emitter	Sensor set	PD140FNT60QMU-02C
Receiver	Not available	PD140FNT60Q-02C
Emitter	Not available	PD140FNT60MU-02C

Structure

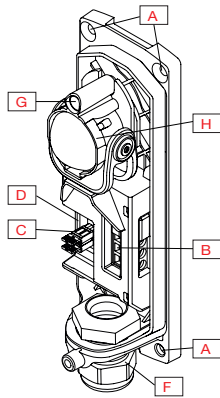

Fig. 1 Emitter

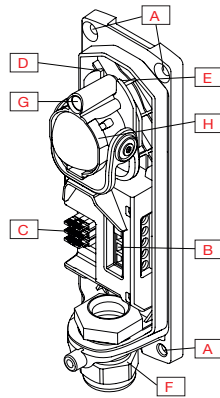

Fig. 2 Receiver

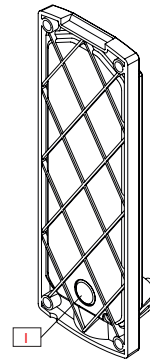

Fig. 3 Rear view

Element	Component	Element	Component
A	Fixing holes for sensor mounting	F	Cable gland for cable entry
B	Terminal block	G	Hole for laser adjustment tool
C	Jumpers	H	Lens adjustment
D	Green LED	I	Alternative cable entry
E	Yellow LED		

Sensing

Detection

Rated operating distance (S_n)	≤ 60 m	@ target, PD140 emitter and excess gain 4
Sensitivity adjustment (Receiver)	12 m ... 60 m	Jumper pos 1
	6 m ... 12 m	Jumper pos 2
	0.6 m ... 6 m	Jumper pos 3
Blind zone	0.6 m	
Hysteresis	10 ... 20%	
Light source	850 nm	Infrared
Light type	Infrared modulated	
Detection angle	≤ ± 5°	
Emitter beam angle	≤ ± 5°	
Light spot size	3.7 m	@30 m (half sensing distance)
Lens adjustment	± 100°	Horizontal
	± 15°	Vertical

Accuracy

Temperature drift	≤ 0.3%/°C
Repeatability	< 5%



Detection diagram

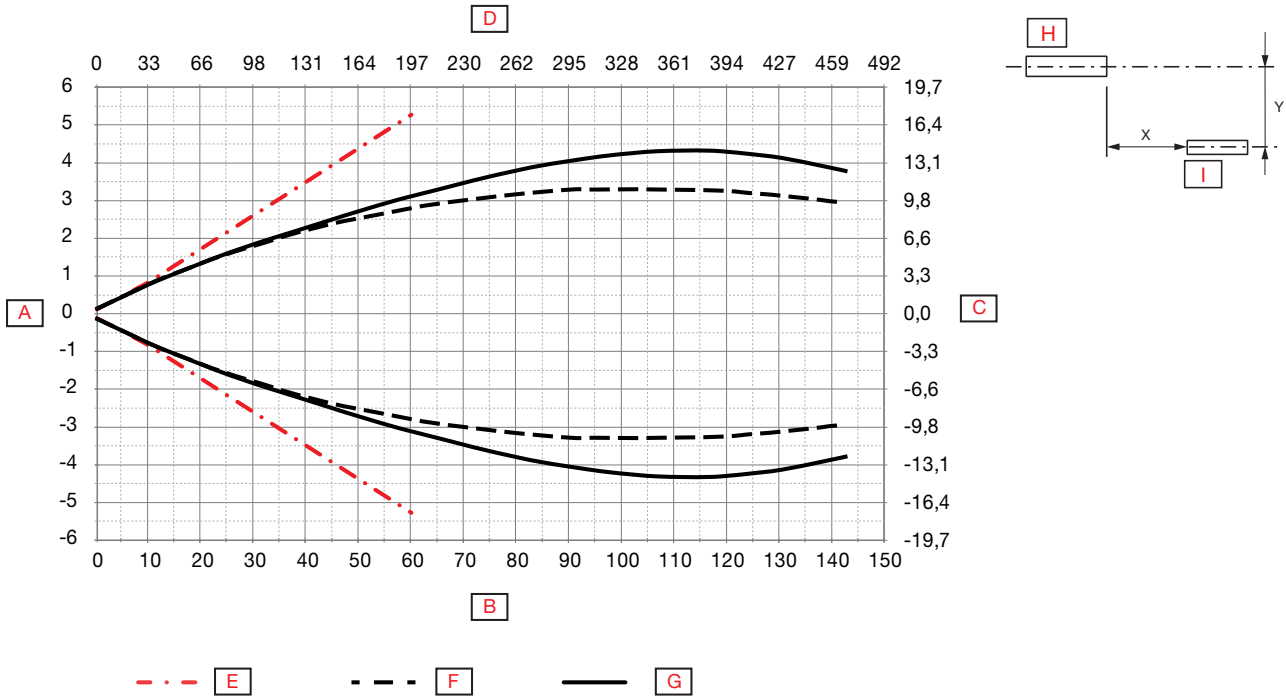

A	Detection width [m]	F	OFF
B	Sensing range [m]	G	ON
C	Detection width [feet]	H	Emitter
D	Sensing range [feet]	I	Receiver
E	Limits		



Excess gain

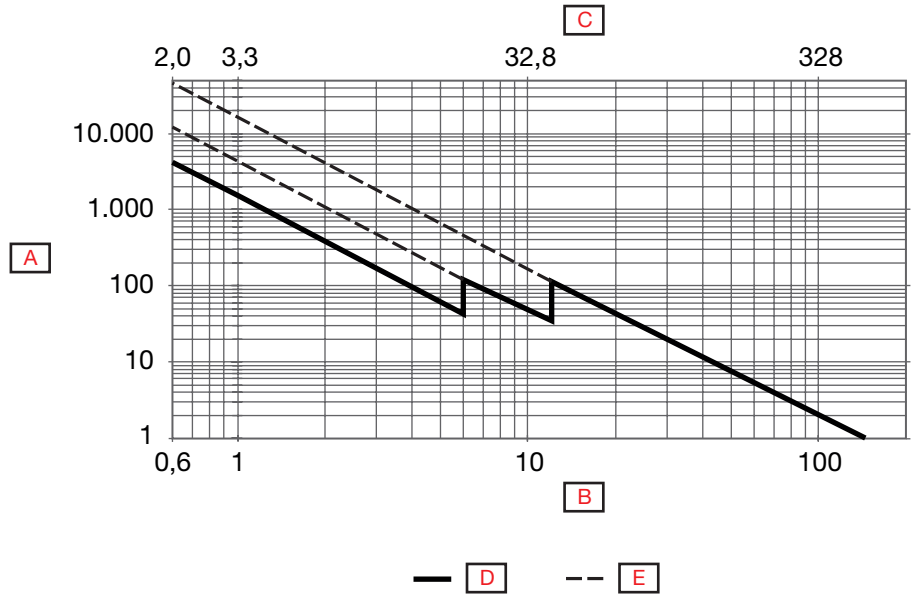

A	Excess gain	D	ESPE 2, legal detection angle ⁵⁾
B	Sensing range [m]	E	ESPE 2, illegal detection angle ⁵⁾
C	Sensing range [feet]		

⁵⁾ See detection diagram



Features

Power Supply

Rated operational voltage ($U_{e-min} - U_{e-max}$)	12 ... 24 V AC/DC (ripple included)	
Rated operational voltage (U_B)	10.2 ... 35 V DC	
	10.2 ... 26.4 V AC	
Ripple (U_{rpp})	Within limits of U_B min	
No load supply current (I_o) DC	≤ 55 mA @ U_B max	Emitter
	≤ 50 mA @ U_B max	Receiver
No load supply current (I_o) AC	≤ 100 mA @ U_B max	Emitter
	≤ 100 mA @ U_B max	Receiver
Power-ON delay (t_v)	≤ 200 ms	Emitter
	≤ 200 ms	Receiver

Outputs

Output functions	SPDT relay	
Output switching function	N.O. and N.C.	
Output current	< 1 A / 30 VDC	Continuous(I_o)
	< 0.5 A / 50 VAC	Continuous(I_o)
Minimum operational current (I_m)	≥ 1 mA @ 5 V	
Mechanical lifetime	$\geq 5\,000\,000$ cycles	
Electrical lifetime (typical)	$> 100\,000$ cycles @ Resistive load AC-1 and DC-1	
Protection	reverse polarity and transients	Emitter and Receiver
Utilization category	AC-1	Non-inductive or slightly inductive loads, resistive load
	DC-1	EN 60947-4-1
	AC-14	Control of small electromagnetic loads EN 60947-5-1
	DC-13	Control of electromagnets EN 60947-5-1 (with freewheeling diode)



Operation diagram

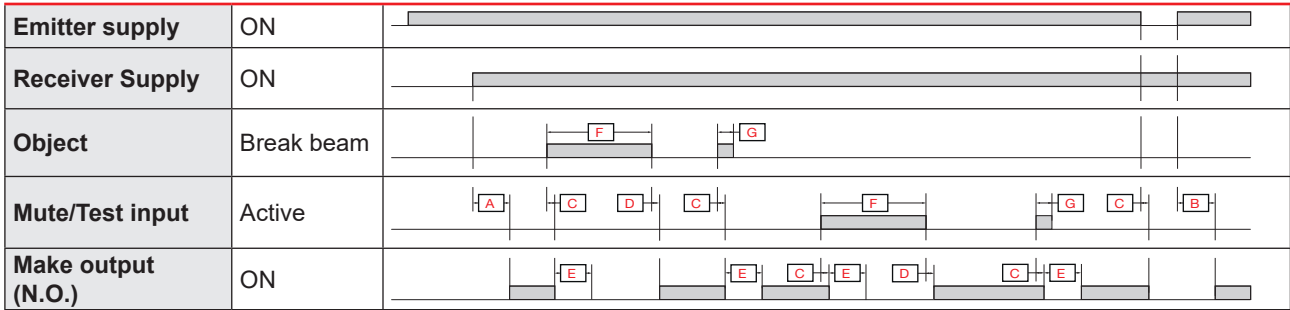

A	Receiver startup time (150 ms)	E	OFF Hold Time (80 ms)
B	Emitter startup time (150 ms)	F	Beam obstruction / mute active > 80 ms
C	Break response time (8 ms)	G	Beam obstruction / mute active < 80 ms
D	Make response time (8 ms)		

Response times

Operating frequency (f)	10 impulses / sec.	
Response times	t _{ON} (ON-OFF)	< 8 ms
	t _{OFF} (OFF-ON)	< 8 ms
	OFF Hold time	> 80 ms

Indication

Receiver

Green LED	Yellow LED	Power	Output
ON	OFF	ON	OFF
ON	ON	ON	ON
ON	Flash ¹⁾	ON; EG ≥ 4	OFF / Alignment mode
OFF	Flash ¹⁾	EG < 4	OFF / Alignment mode

¹⁾ Slow flashing or OFF = Not aligned, Higher flash rate= Better optical alignment
EG = Excess gain

Emitter

Green LED	Yellow LED	Power	Emitting
ON	-	ON	Yes
OFF	-	ON	No (muted)



Environmental

Ambient temperature	-25°... +60°C (-13°... +140°F)	Operating ^{2) 3)}
	-40° ... +70°C (-40° ... +158°F)	Storage ²⁾
Ambient light	≥ 100 000 lux	Incandescent light @ 3000 ... 3200 °K (EN 60947-5-2)
	≥ 10 000 lux ⁴⁾	Incandescent light 3200 °K (EN 61496-2)
	≥ 3 000 lux ⁴⁾	Fluorescent light (EN 61496-2)
	0.05 J @ 200 Hz to 0.5 J @ 5 Hz ⁴⁾	Stroboscopic light (EN 61496-2)
	3 to 5 J @ 0.5 to 2 Hz ⁴⁾	Flashing beacon light (EN 61496-2)
Vibration	10 ...150 Hz, 1.0 mm/15 g	EN 60068-2-6
Shock	30 g _n / 11ms, 6 pos, 6 neg per axis	EN60068-2-27
Drop test	2 x 1 m and 100 x 0.5 m	EN 60068-2-31
Rated insulation voltage (U_i)	50 VDC	
Dielectric insulation voltage	≥ 4000 VAC rms	50/60 Hz for 1 min.
Rated impulse withstand voltage	≥ 2 kV	1.2/50 μs
Pollution degree	3	EN60947-1
Overvoltage category	III	IEC60664; EN60947-1
Degree of protection	IP65	IEC60539; EN60947-1
NEMA Enclosure Types	Indoor + outdoor: 3, 3R, 3RX, 3SX, 3X	NEMA 250
	Indoor: 1, 2, 5, 12, 12K	NEMA 250
Ambient humidity range	RH < 50% @ 70°C ²⁾	
	RH < 90% @ 20°C ²⁾	

- 2) With no icing or condensation
- 3) UL325 -25°... +55°C
- 4) Failure to danger (worst case alignment)

EMC

Electrostatic discharge immunity test	± 8 kV @ air discharge	IEC 61000-4-2
	± 15 kV @ contact discharge (Closed sensor with aluminium housing)	
	± 8 kV @ contact discharge (during installation)	
Radiated radio-frequency electromagnetic field immunity test (80 MHz ... 1 GHz and 1.4 GHz ... 2 GHz)	10 V/m	IEC 61000-4-3
Electrical fast transient/Burst immunity test	4 kV / 5 kHz using the capacitive coupling clamp	IEC 61000-4-4
Conducted disturbances induced by radio-frequency fields immunity test (150 kHz ... 80 MHz)	10 V rms	IEC 61000-4-6
Power frequency magnetic field immunity test	300 A/m	IEC 61000-4-8

Mechanics/electronics

▶ Connection

Cable diameter	Ø 5 ... 10 mm	
Connection	3-pole screw terminal	Emitter
	5-pole screw terminal	Receiver
Terminal	Self-lifting terminal block, 1.5 mm ² (AWG 16) □ 2.6 x 2 mm	

▶ Wiring

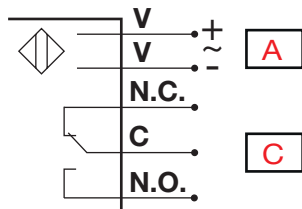

Fig. 4 Receiver

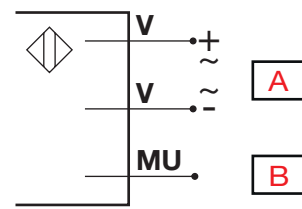

Fig. 5 Emitter

A	B	C
Power supply	Mute input (Test input)	Relay contacts

▶ Housing

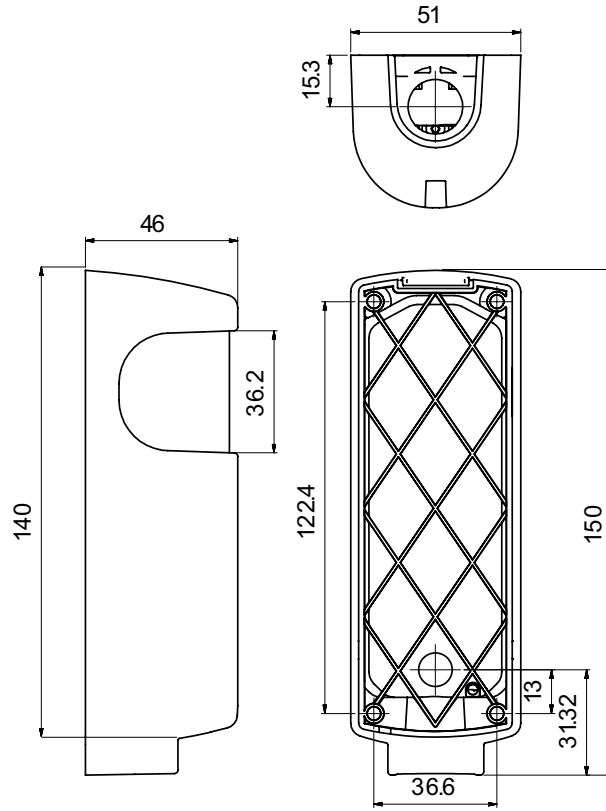

Cover	Aluminium, Black
Window	PC, Black
Back part	PBT, Black
Sealing	Neoprene
Cable gland	PA6, Light grey
Dimensions	140 x 51 x 46 mm
Weight	≤ 460 g (matched set)

Dimensions (mm)



Compatibility and conformity

Approvals and markings

General reference	Sensor designed according to EN60947-5-2	
MTTF_d related to product life time	49.9 years @ 40°C (+104°F)	EN ISO 13849-1 (Parts count method, annex D.1), SN 29500
MTTF_d related to safety device, performance level_d	1332 years @ 40°C (+104°F)	EN ISO 13849-1, SN 29500
CE-marking		
Approvals		
ESPE category	2	EN61496-2
Performance level (PL)	d	EN12453
PFH_d	8.57 x 10 ⁻⁸ Errors per hour	EN ISO 13849-1
Mission Time	20 years	EN ISO 13849-1



Delivery contents and accessories

▶ Delivery contents

- Photoelectric sensor set: PD140FNT60Q-02C + PD140FNT60MU-02C
- Accessory bag (Screws, plugs, blind caps, cable glands)
- Packaging: Card board box

▶ Accessories

- Laser alignment tool: APD140-LA01
- Laser alignment tool without batteries (Battery: DL1/3N, CR1/3N 3V - Lithium): APD140-LA02
- Alignment test cable: APD140-TC01

▶ Further information

Information	Where to find it	QR
Manual	http://cga.pub/?6ddc71	



COPYRIGHT ©2020
 Content subject to change. Download the PDF: www.gavazziautomation.com